

> W2



Welcome to the family of S3 owners! We will guide you to know each function for the right and safe use of Electric scooters. To ensure your safety, please read this manual carefully before riding and make sure you are always following the requirements below:

- Fully understand the information in this manual, including but not limited to the relevant instructions, precautions and warnings.
- Fully understand the operation and contingency measures of electric scooters.
- Be fully aware of warning labels of S3 electric scooters.
- We will not take any responsibility resulting from the unauthorized modification, failure to use original spare parts, or installation of components that affect the performance and safety of the scooter.

Please contact the Local Customer Service Center if you have any questions about this bike. We are at our service at any time. Wish you safe and pleasant riding experience!

Safety Instructions

To ensure the safety of you and others, please make sure to observe the following matters:

- Do not ride after you take medications which may affect your riding ability, drink alcohol, or when you are unwell.
- Observe traffic regulations and traffic signs and confirm the surrounding road conditions and scooter conditions at any time, so as to actively avoid danger.
- Wear safety equipment, such as helmet, and appropriate protective clothing if necessary, such as gloves and boots.
- Perform a basic check each time before riding, so as to confirm the light, brake, tread and tire pressure and check other parts for looseness or abnormal noise, and regularly go to Local Service Center for maintenance.
- In order to ensure the safety of you and others, please DO NOT use high beam in good lighting conditions. The continuous use of high beam will cause the visual disturbance to vehicles and pedestrians on the opposite side, thus affecting normal driving.
- Please do not make or answer any call during riding, which is likely to cause traffic accidents.

Installation of Mirrors

1

Take out the Left and Right mirrors, Insert the hole and rotate the mirror clockwise to the correct position.

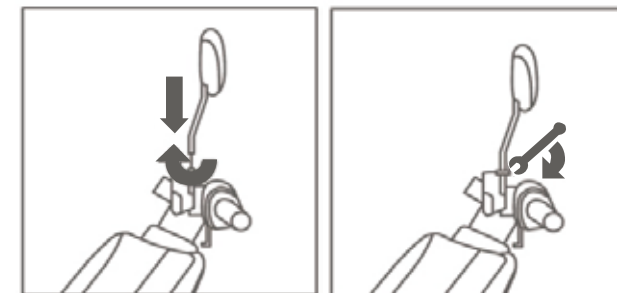

2

Use the spanner to fasten the nut, make sure the left and right mirror is on the same line and suitable for the driver's view.

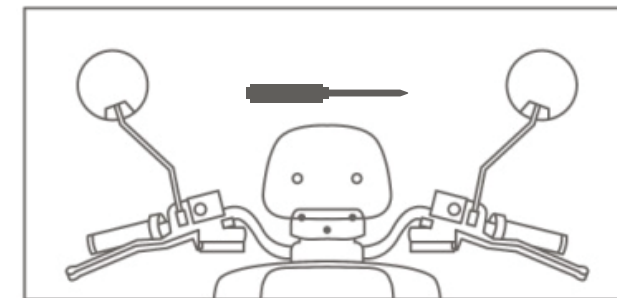

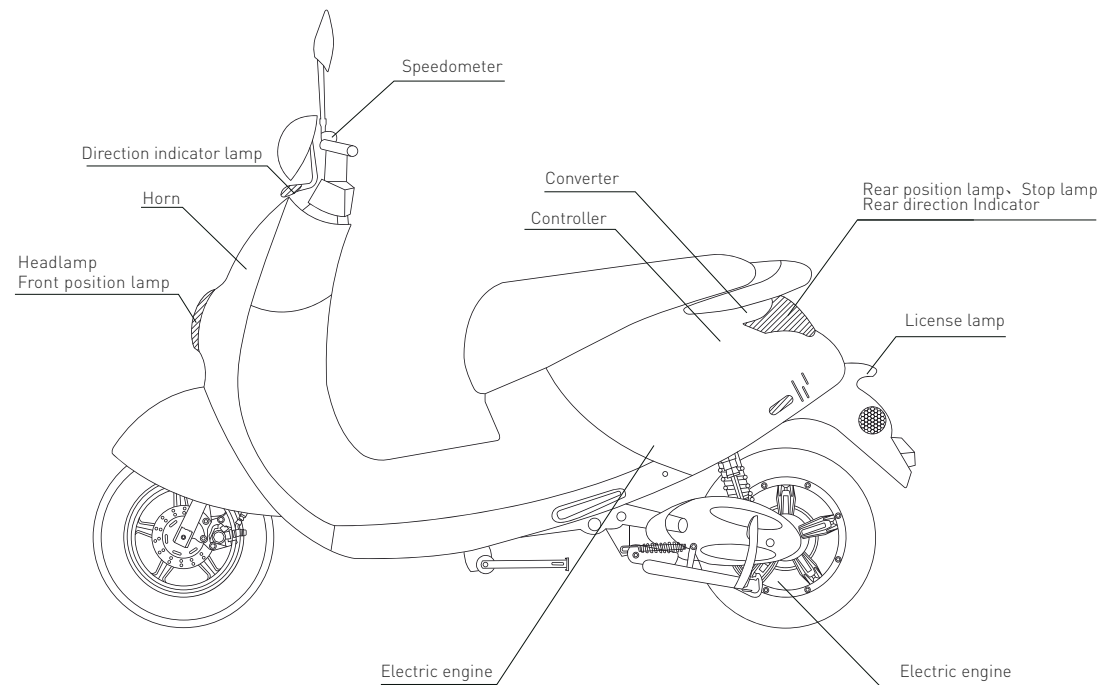
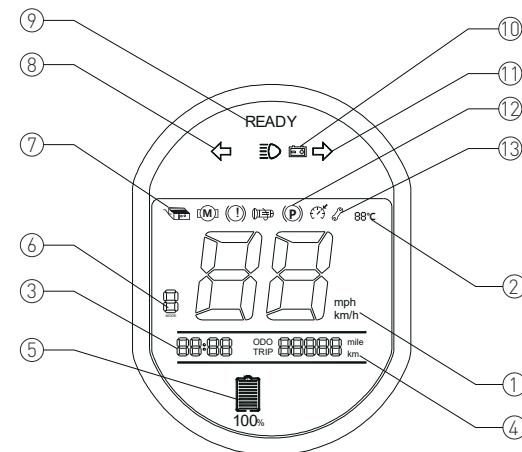



















Diagram of Instrument Panel



- ① **Speed display** - Display current speed.
- ② **Ambient temperature** - Display current temperature.
- ③ **Driving time** - Display Single driving time.
- ④ **ODO/TRIP** - Total ODO Distance/ TRIP distance.
- ⑤ **Power display bar** - Display current battery level.
- ⑥ **Gear display** - Display current gear.
- ⑦ **Failure warning** - Display current Failure (Motor, Controller, Brake, Accelerator)
- ⑧ **Left Winker indicator** - Flashing in synchronization.
- ⑨ **READY light** - Ready for driving.
- ⑩ **The charge indicating lamp of Battery** - Light up when battery's low capacity.
- ⑪ **Right Winker indicator** - Flashing in synchronization.
- ⑫ **Parking gear** - Parking the scooter.
- ⑬ **Recover display** - When the scooter have failure warning on the Components.

(motor/controller/brake/accelerator), always press this button, driving the scooter slowly to find the nearest service.

Details of Instrument Panel

Lamp	Function	Lamp	Function
READY	Power on	↔	Left/Right Indicator
	High/Low beam Indicator		Parking gear
	Gear display		Battery power capacity
	Battery's Low-voltage Indicator		Speed display (kmph/mph)
	ODO miles when start, TRIP miles after 30 seconds		Single drive time
	Failure warning of Controller		Ambient temperature display
	Failure warning of Brake		Failure warning of Motor
	Position light and Daytime light		Failure warning of Speed accelerator
	Parking gear		High beam light
			Low battery warning

How To Operate The Smart Remote Control

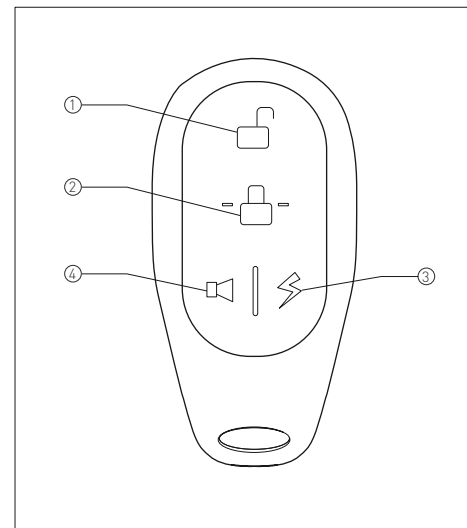

With the advanced Smart Remote Controller, you can easily lock or unlock your electric scooter by simply pressing the button within 50 meters.

- ① **Unlock**
Press the unlock button, and the start button stays on. The scooter enters into the [Unlocked State].
- ② **Lock**
When the scooter is in the [Static State], press the lock button, and the start button flashes. The scooter enters the [Locked State].
- ③ **Remote keyless entry**
After unlock the scooter, press this button twice within two[2] seconds, and the scooter will be in the "Powered" state without key.
- ④ **Search key**
Press this witch within 50m, "Bi Bi" sounds searching the scooter.

Left Start Button

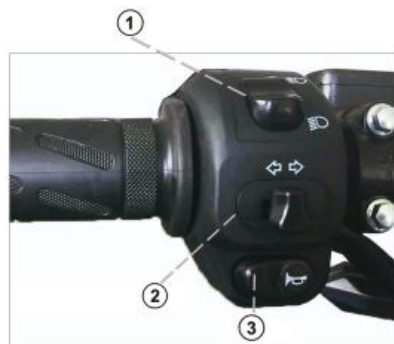

① High/Low beam switch button

Press up to turn on the high beam.
Press down to turn on the low beam.

② Winker button

Dial to the left side to turn on the Left winker.
Dial to the right side to turn on the Right winker.

③ Horn button

Press to make a sound and release to stop.

Right Start Button



① Gear shift button

The bike has three(3) Gear modes, 1 "Eco", 2 "Cruise", and 3 "Sport". Dial rightwards for "Eco", middle for "normal" and left for "sport".

② Headlamp button

 Dial up to turn on the headlamp. Turn downward to AUTO to automatically turn on the headlights. The headlights turn on automatically according to the brightness of the environment.

 Dial down to turn off the headlamp.

③ Parking button

Parking button has two modes: press to park the bike and parking indicator P goes on; and press again to exit the parking status.

④ Recover button

When the scooter has a failure warning on the motor/Controller/Brake/Accelerator, always press this button, slow driving to nearby service center for repairs.

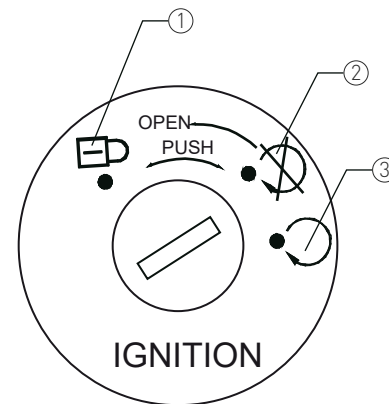

① After the scooter stops, turn the handlebar to the far left, insert the key into the physical handlebar lock, push and rotate it leftwards to lock the scooter.

Insert the key into the physical handlebar lock, and rotate it rightwards to unlock the scooter.

② Insert the key and rotate it leftwards, open the saddle and the storage box will be opened when you hear a [Click] sound.

③ Insert the key and rotate it rightwards, to start the scooter for driving.

Operation of Air switch

As the protection switch for the main power of electric scooter, the air switch will automatically disconnect to ensure safety when the scooter circuit is abnormal or the current caused by short circuit exceeds the set safe value.

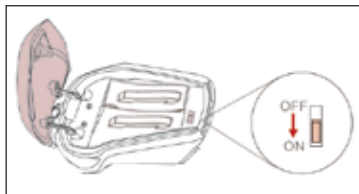

① Air switch ON/OFF

Before open the key, please turn ON this Air switch in advance.

NOTES: In order to protect your safety, please turn off the air switch when cleaning, storing the scooter for a long time, or re-moving the battery pack.

② Open the Seat with the key, plug the battery cable inside the socket, connecting the battery with scooter.

③ Unlock and Remove the battery case step by step

Open the Seat with the key, unplug the power cable, then pull up the battery case with one hand.



Checks Before Riding

Make sure to check the following items before riding a Electric Scooter, which will guarantee your safety on the road.

- ① Whether the handlebar is stable and flexible when turning.
- ② Whether the switches on the right and left handlebars can work normally.
- ③ Whether the speed accelerator can work normally.
Make sure the tire pressure is normal. The suggested tire pressure is 26-29psi for front wheel and 29-32 psi for rear wheel.
- ④ Check tire surface for cracks, damage, wear, and foreign matter puncture or attachment
- ⑤ Whether the tread depth is sufficient (>0.8 mm).
- ⑥ Whether any fault warning light on the instrument panel goes on after being powered.
- ⑦ Whether the battery is fully charged.
- ⑧ Whether the head and tail lights, brake lights and wipers can work normally.
- ⑨ Whether the horn can work normally.
- ⑩ Whether the rear mirrors are clean. Adjust them to the appropriate angle.
- ⑪ Whether the brake oil is sufficient, and whether the handlebars and brake system can work normally.
- ⑫ For any abnormality or operational concern, please contact local Customer Service Center.

Make sure to check the following items before riding, which will guarantee your safety on the road.

- ① Insert the key and turn leftwards, Open the saddle, open the cap to connect the battery cable, Turn On the Air switch.



- ② Put on the helmet, and retract the electronic side stand.



- ③ Insert the key and turn leftwards, "Powered" state is started, the Instrument is opened, and the "READY" light is ON, scooter is ready for driving now.



- ④ Press the "P" button with three(3) seconds, to exit the Parking state, and the "P" indicator goes off, then you can start driving. Gently turn the handlebar to ride on the road.



TIPS:

Before riding, make sure the electronic side stand is retracted and rotate the handlebar to ensure that the handlebar lock is closed. If the Parking button is pressed when riding, the bike will be dis-energized. So DO NOT press it when riding for avoiding danger caused by the sudden loss of power.

If the electronic side stand is extended when riding, the bike will be dis-energized. So DO NOT extend the electronic side stand when riding for avoiding danger caused by the sudden loss of power.

The scooter must be fully stopped before starting. In case of abnormality during riding, please ride carefully or push it to a safe place. DO NOT try restarting the bike during riding or on the lane so as to avoid danger.

How to Charge the Battery

- ① Insert the main charger plug into the charging port of the scooter.

Insert the charger's AC power plug into the home power socket, and the battery starts charging when the charger indicator turns red. The battery is fully charged if the charger indicator turns from red to green.

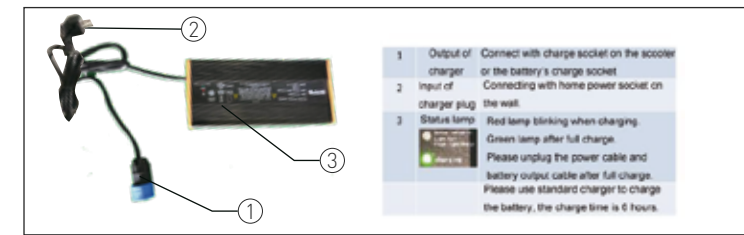
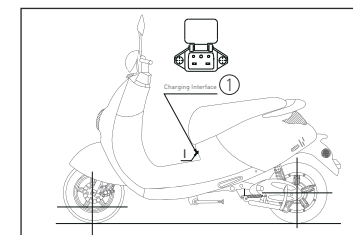

How to Charge the Battery

- ② Pull up the battery from scooter, insert the main charger plug into the charging socket of the battery. Insert the charger's AC power plug into the home power socket, and the battery starts charging when the charger indicator turns red. The battery is fully charged if the charger indicator turns from red to green.

TIPS:

Short circuit of the cathode and the anode at the battery's input.

Keep it away from children, fire and heat source. It is strictly forbidden to throw it into the fire; violent movements, shock and extrusion are prohibited;

Only the specified charger can be used, and other chargers are prohibited to charge the battery;

This product has been subject to strict inspection before leaving factory, and it is strictly prohibited to dismantle it. Please contact our company's after-sales department for any question.

TIPS:

Do not expose the battery to water, and prevent it from being damped by water or rained.

Charge temperature: 0-45 °C, discharge temperature: -20-45 °C;

Battery capacity will be reduced when placed in a low-temperature environment;

Charge the battery when you use it, but make sure to charge it before the capacity is lower than 20%. When it is not used for a long time, please remove it from the scooter.

Storage, Maintenance and Transportation

Please charge the battery to half-saturation state when storing or transporting it (after the battery is discharged, charge it for 3 hours). Place it in a dry and ventilated place;

Battery and charger should be kept in a clean, dry, and ventilated place. Keep them away from corrosive materials, power source and heat source;

Storage conditions: ambient temperature -20-35 °C, humidity <65% RH;

When storing the charger, please disconnect it from the battery.

Regular maintenance can enhance the service life and driving safety of the electric scooter. Please refer to the following suggestions and take care of your scooter.

Routine Cleaning and Maintenance

Cleaning: Please use clean water and neutral detergent to clean it, and use soft cloths and sponges to clean the surface;

It is prohibited to use metal brushes, sandpaper or the like to clean it, in order not to scratch the parts surface. After cleaning, dry it with soft cloths.

TIPS:

Please disconnect the air switch before cleaning.

Do not use strong water jet to directly wash it, so as to avoid the default of mechanical parts caused by water invasion.

Storage: try to park it in a dry and cool room to reduce the exposure to sun and rain and avoid the reduction of service life due to corrosion of parts.

When left unused for a long time, please turn off the air switch and disconnect the power supply circuit to prevent over discharging.

After long-term storage, please fully charge it before use.

Regular Inspection and Maintenance

The new scooter must be subject to the first inspection and maintenance in the Service Center when it reaches 1,000 km or two months (whichever comes first).

The scooter is recommended to be subject to regular inspection and maintenance in the Service Center at every 3,000 km or six months (whichever comes first).

TIPS:

Please disconnect the air switch before cleaning.

Do not use strong water jet to directly wash it, so as to avoid the fault of mechanical parts caused by being damped.

Regular maintenance can improve the service life and driving safety of the electric scooters.

Please refer to the following suggestions and take care of your scooter.

Failure	Causes	Solutions
The scooter has no electricity, and the READY lamp does not shine.	Battery is poorly connected. Air switch is not turned on.	Connect the battery properly at its main plug. Turn on the air switch.
When turning the speed regulating steering handle-bar, the motor does not turn after being powered.	Low battery volume. Side stand is not retracted. Brake handle does not reach the right position. Steering handlebar failure. The controller plug is loose. Controller failure.	Charge the battery. Put away the side stand. Close the parking key. Place the brake handle at the right position. Change handlebar. Re-plug controller. Change controller.
Speed is slow or mileage is short.	Low battery. Under-inflated tire. Heavily overloaded. Brake pads interference. Battery aging or normal scrap.	Charge the battery. Inflate the tire, and check the tire pressure before riding. Foster a good habit, and keep the appropriate load Change the brake pads and check the brake system before riding. Change battery. Check whether the main plug is in a right place Use the special charger.
Battery can not be charged.	Poor contact of the main plug of the charger. Do not use the wrong charger. Battery aging or normal scrap. Battery low-voltage protection.	Contact of the main plug again. Contact with local service office of battery.

ROUTINE CLEANING AND MAINTENANCE

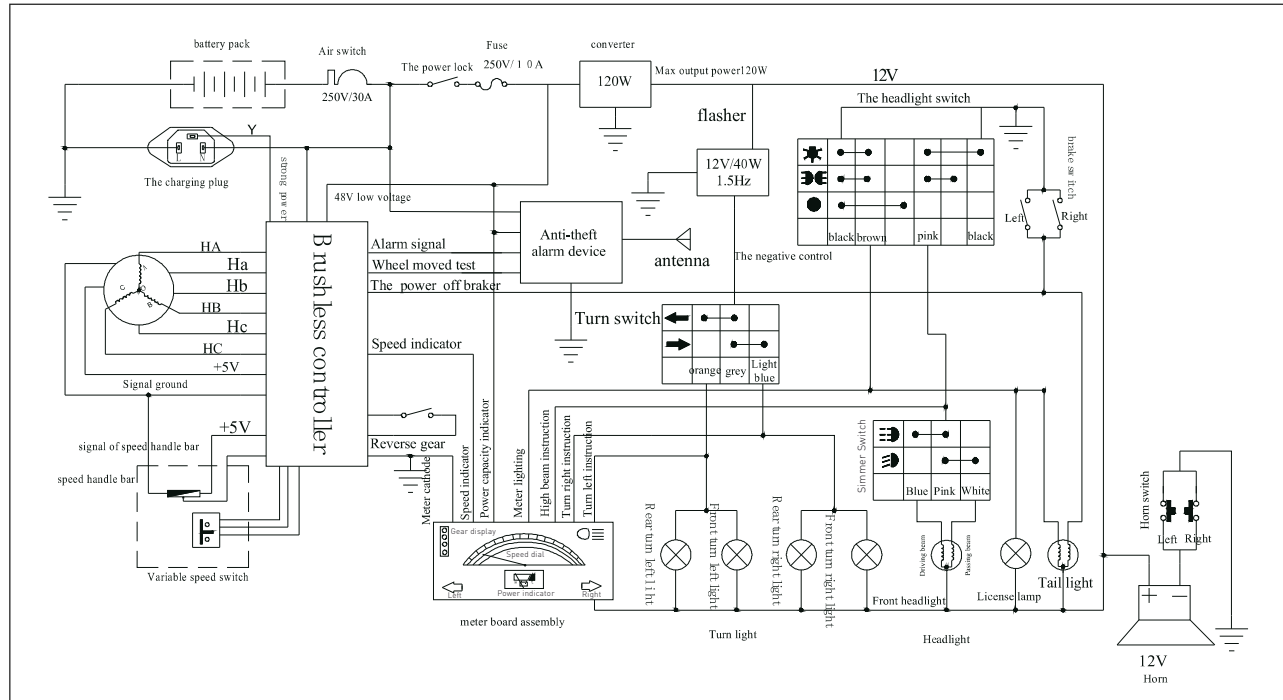

WAYEL Electricbikes

FIVE SRL

Via Cerodolo 4 | 40138 Bologna | Italy

T +39 051 0316272 | www.wayel.it | info@wayel.it